

Beginning Sound Letter Mm Worksheets!

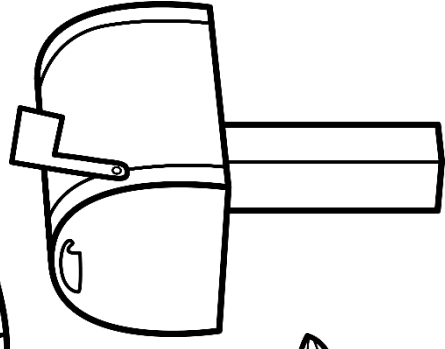

Name: _____

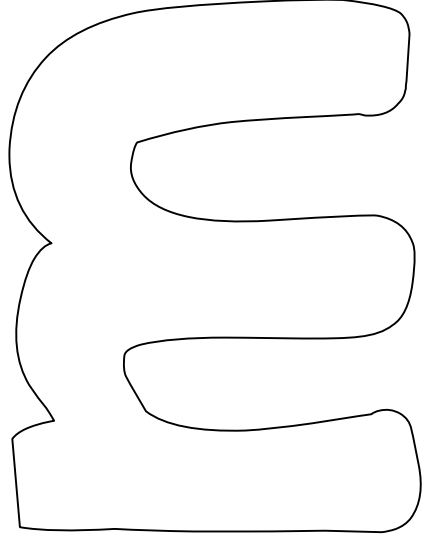
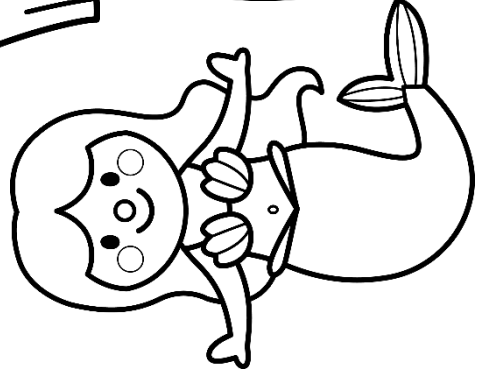
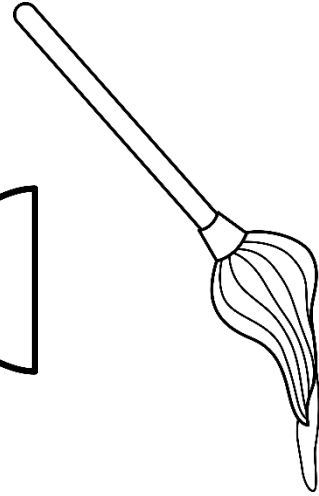
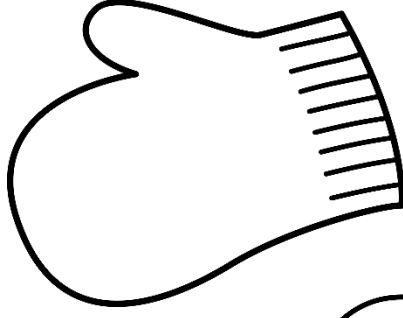
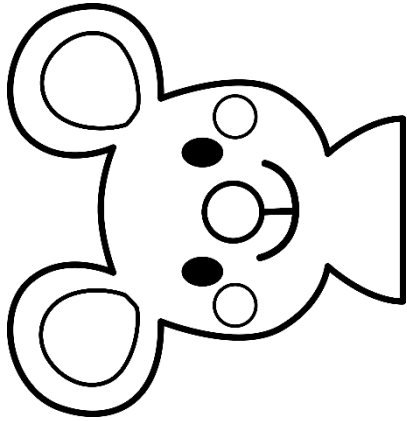
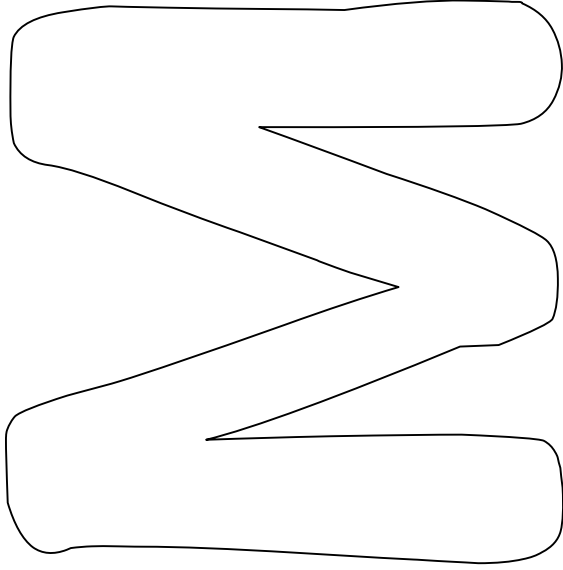
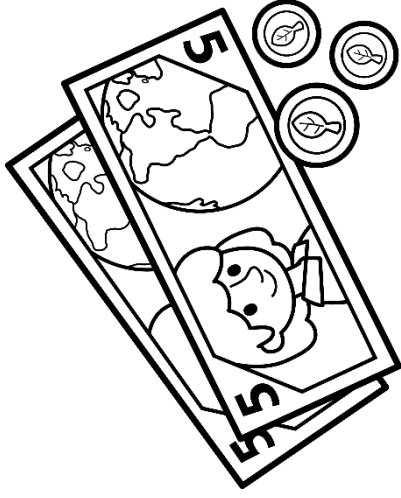
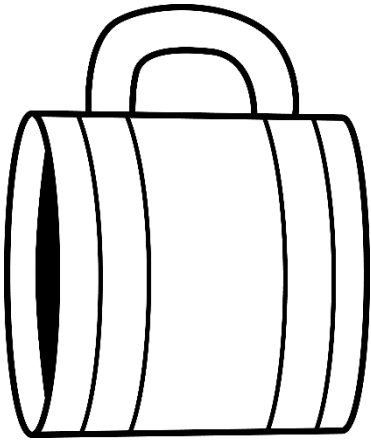

Color it.

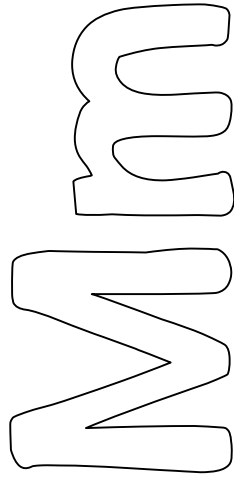

Say words that begin with M.

Highlight it.

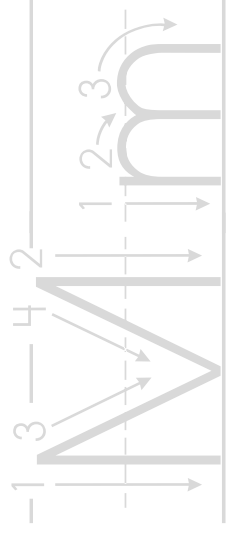

Write it.

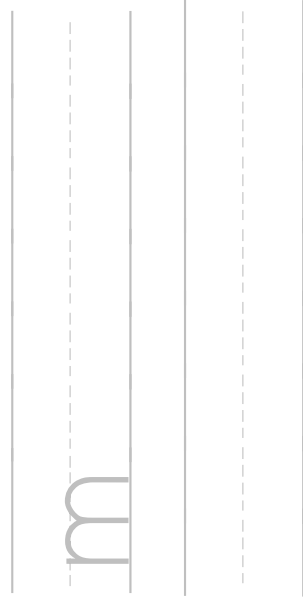

Sign it.

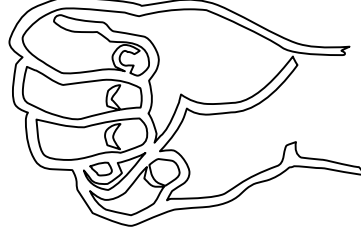

My M book

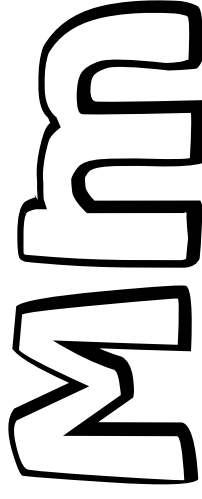

Name: _____

Name: _____

Highlight it.

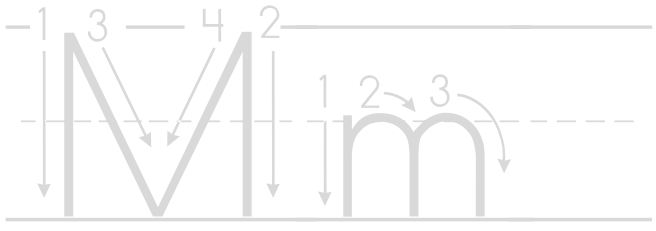

Trace it.

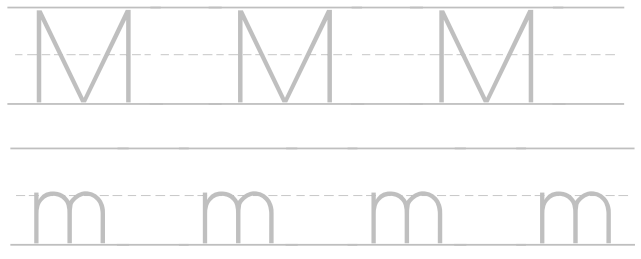

Write it.

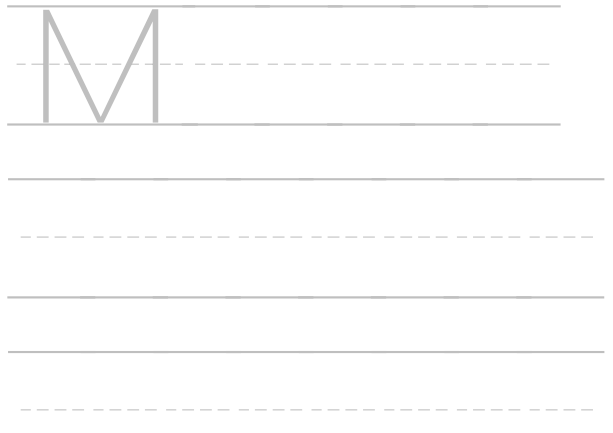

Write it.



Color it.

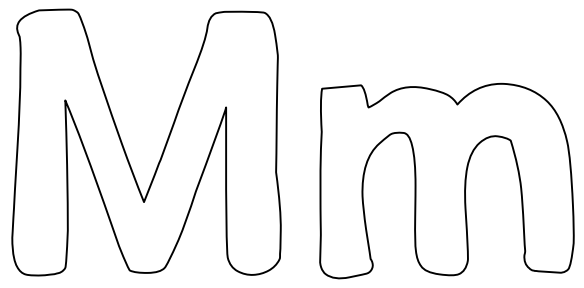

Sign it.



Name: _____

Trace and write the words.

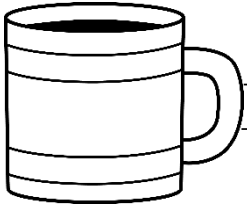

mug

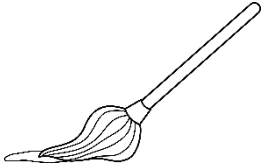

mop

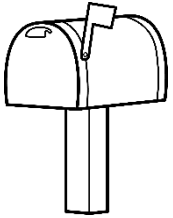

mailbox

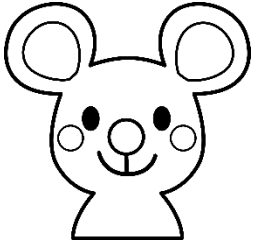

mouse



mitten

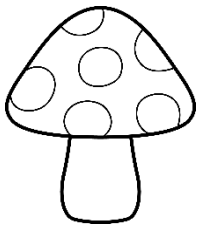

mushroom

Name: _____

Color the m red.
Color the M blue.

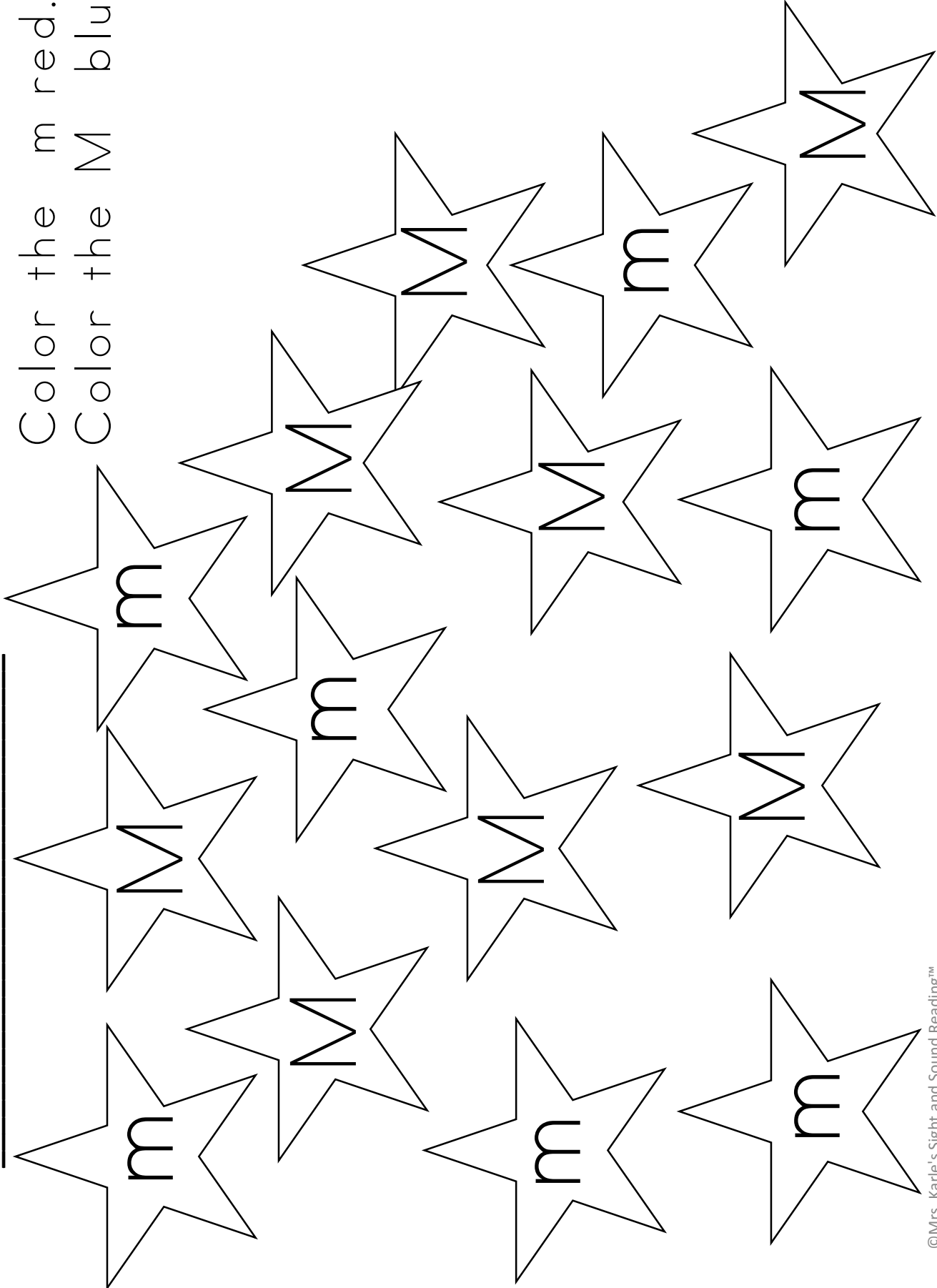

Name: _____

Trace the letter M and m.

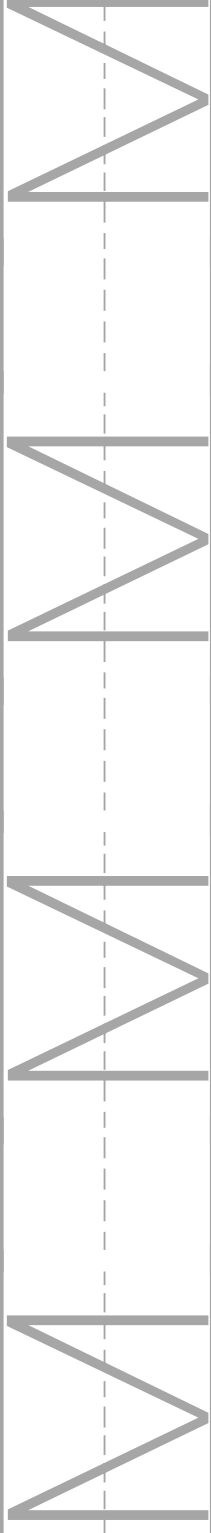

Color the pictures that begin with the letter m.

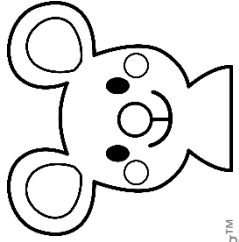
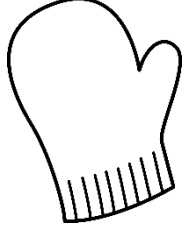
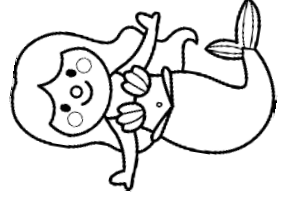
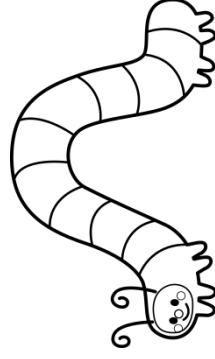
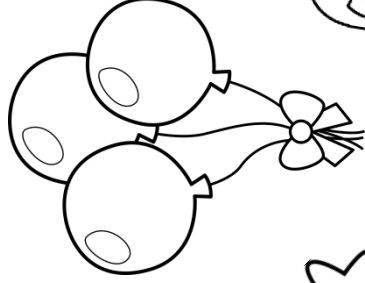
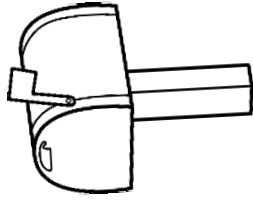
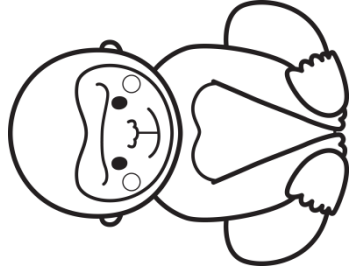
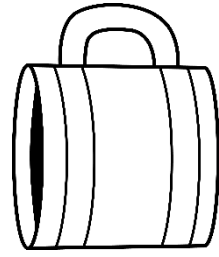

Name: _____

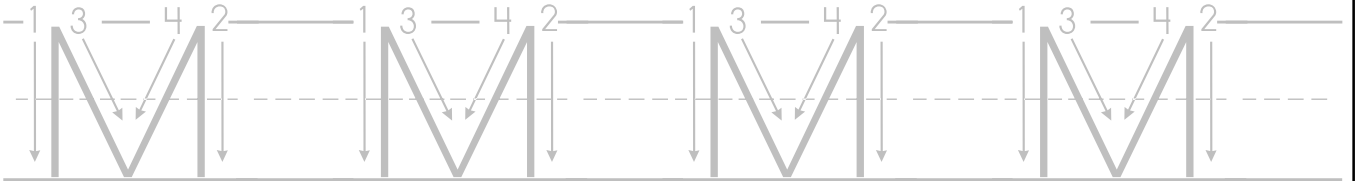
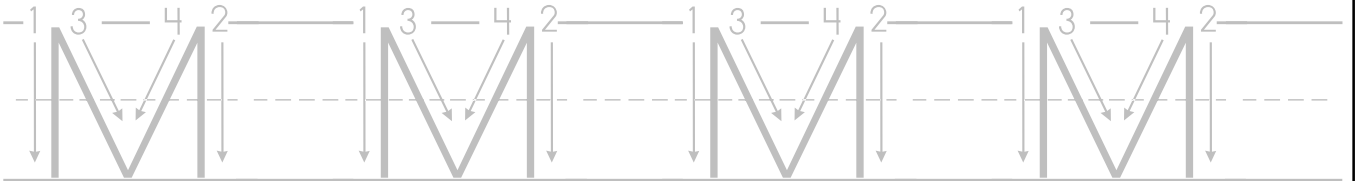
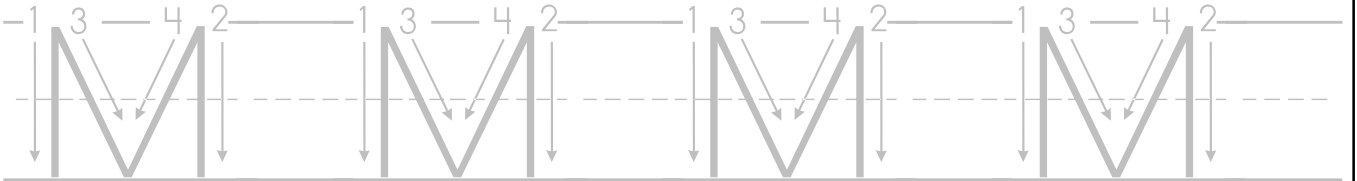
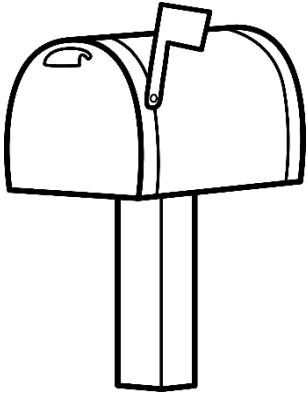
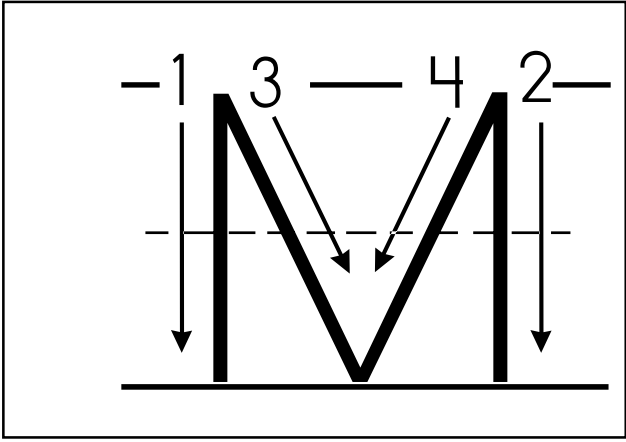

Name: _____

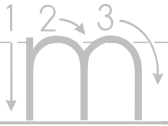
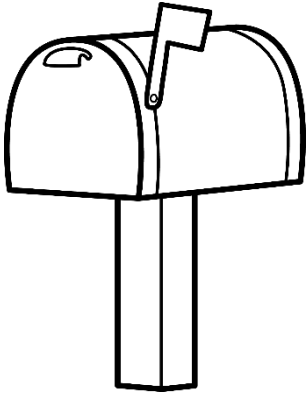
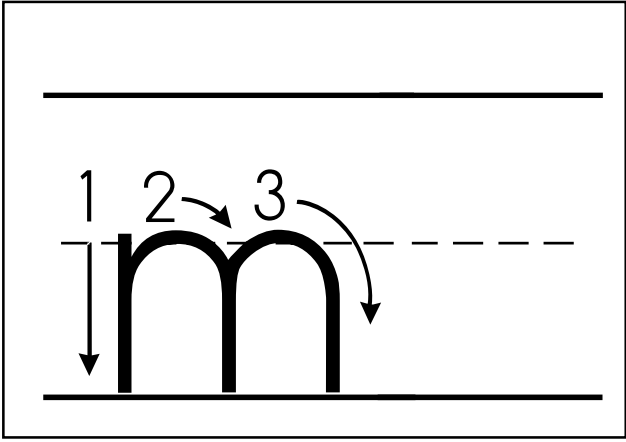

Handwriting practice lines consisting of multiple sets of three horizontal lines (top solid, middle dashed, bottom solid) for practicing the letter 'm'.

Name: _____

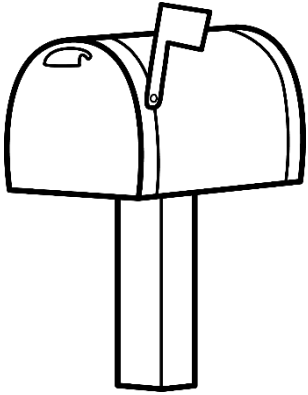
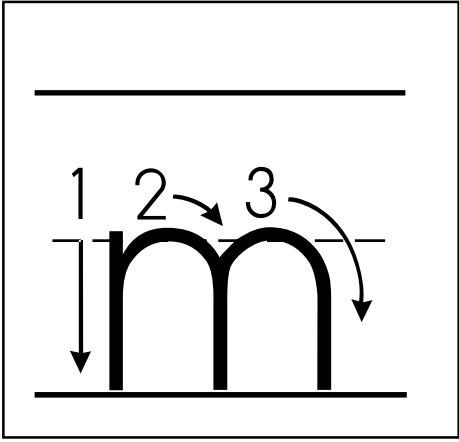

Name: _____

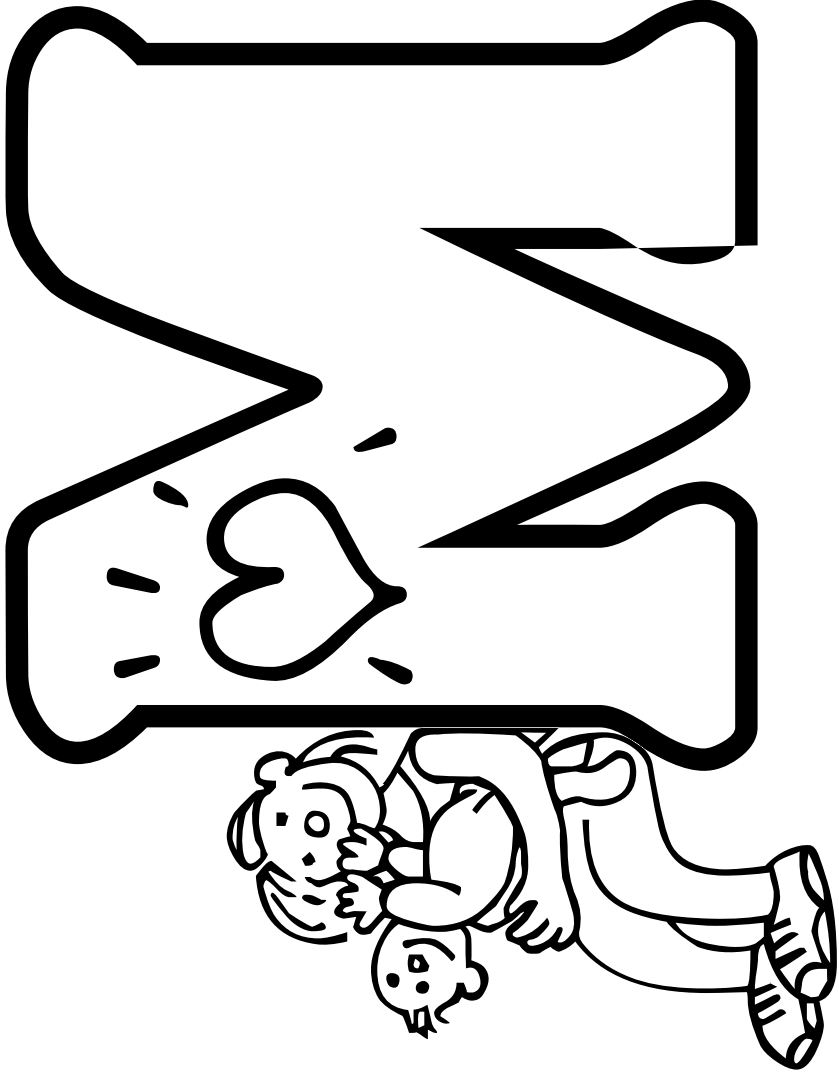

Color and Cut.

Name: _____

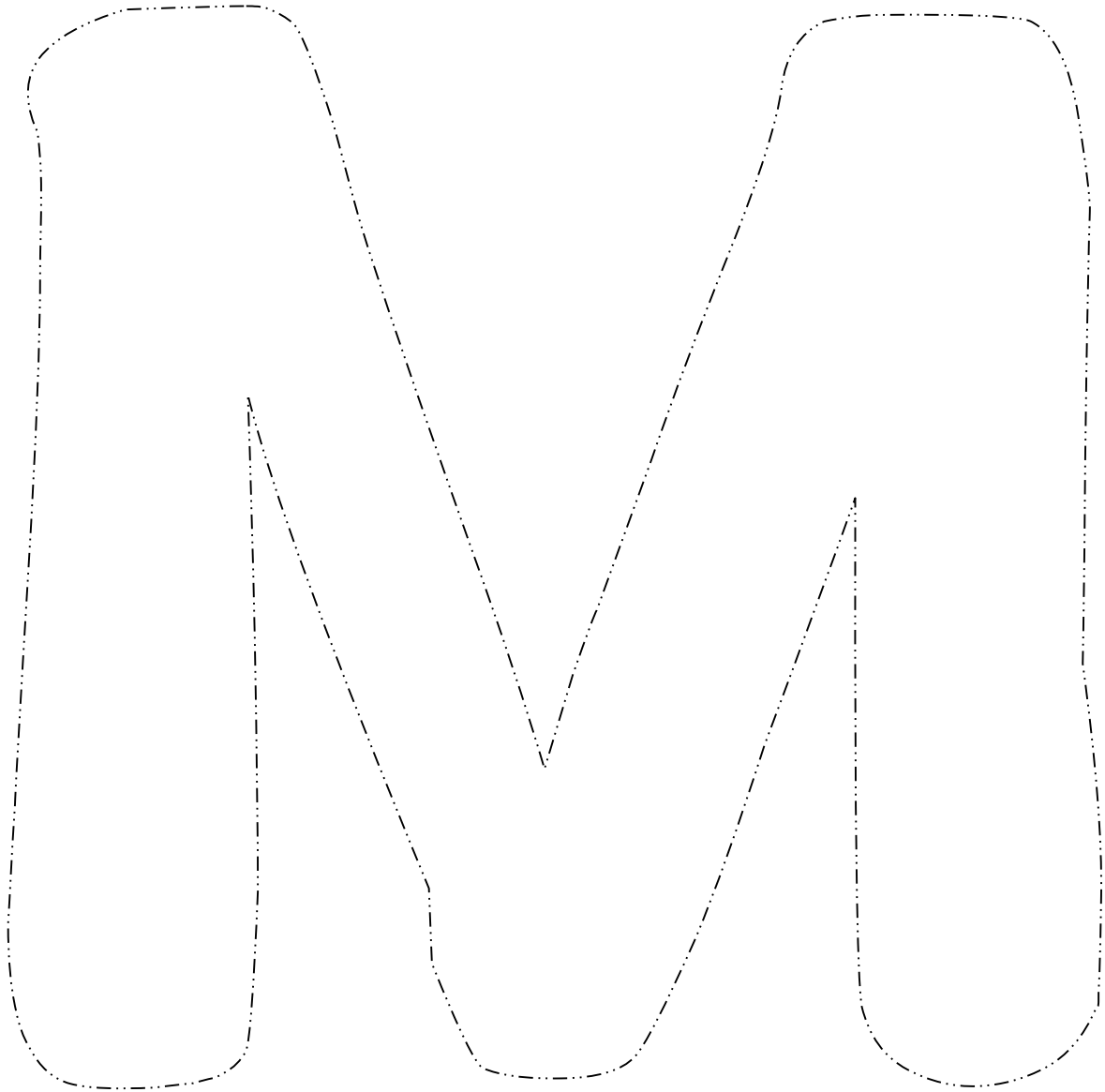
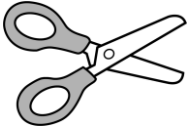

Read, trace and draw a picture of the words that begin with m.

Name: _____

m i t t e n

m u g

m a i l b o x

m o u s e

Name: _____ Cut and Paste the upper and lower case letters.

Upper Case

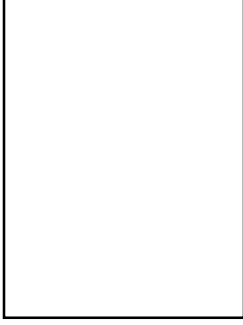
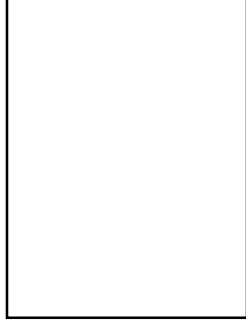
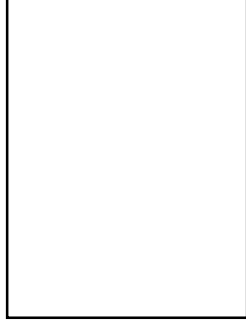
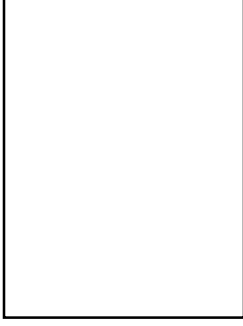
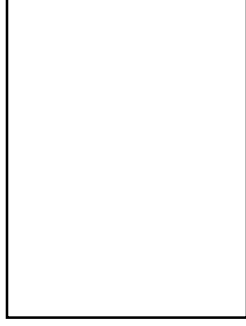
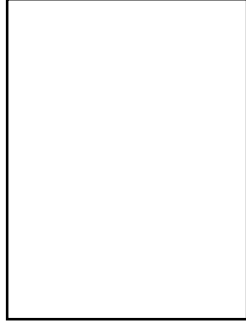

Lower Case

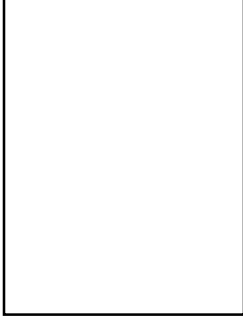
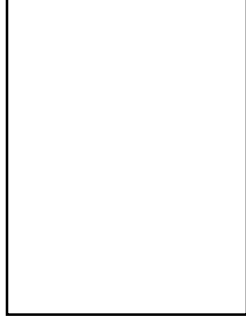
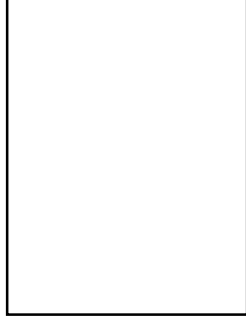
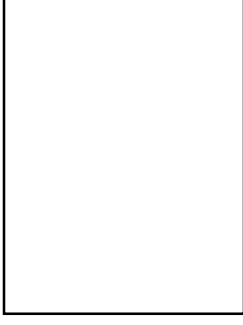
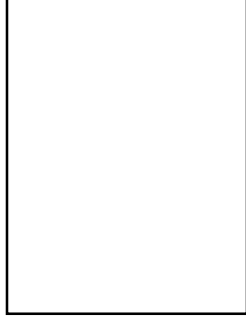
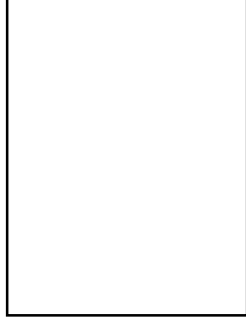

M

m

M

M

M

m

M

m

m

m

m

M

Name: _____

Trace and Write:

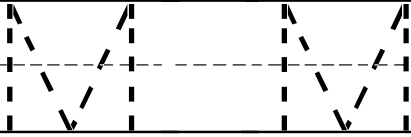

Trace and Write:



Cut and Paste the letters from below. :



Color the little 'm' red. Color the big M blue.

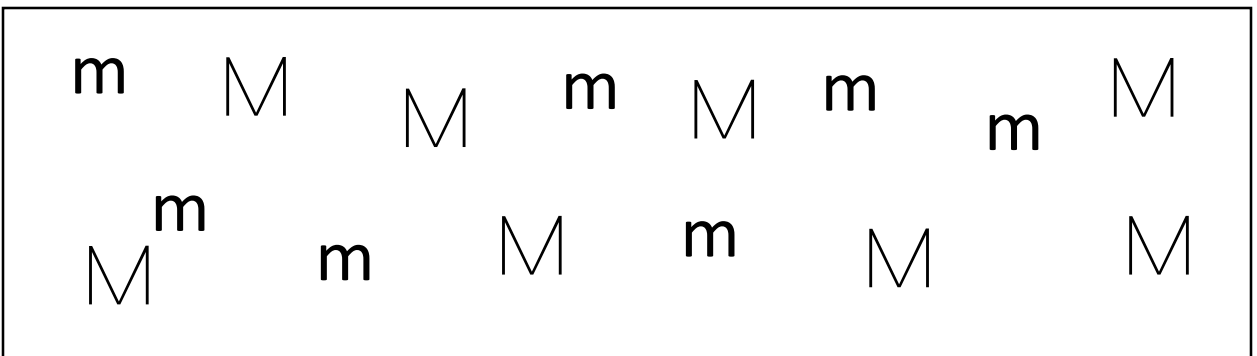

Name: _____

Cut and paste pictures that begin with m.

Trace the upper and lower case letter m.

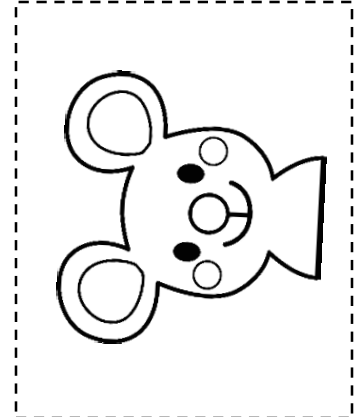
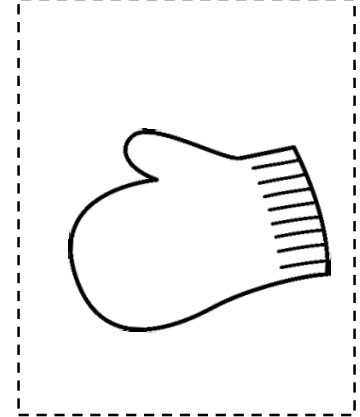
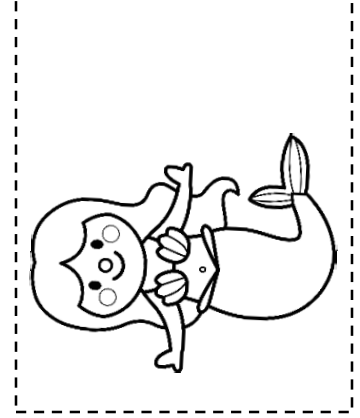
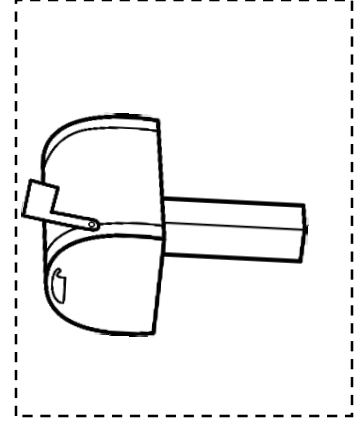
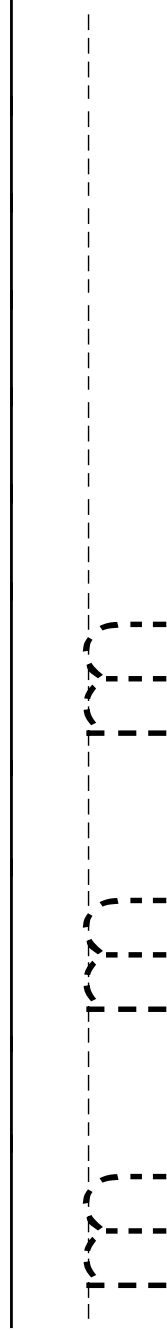
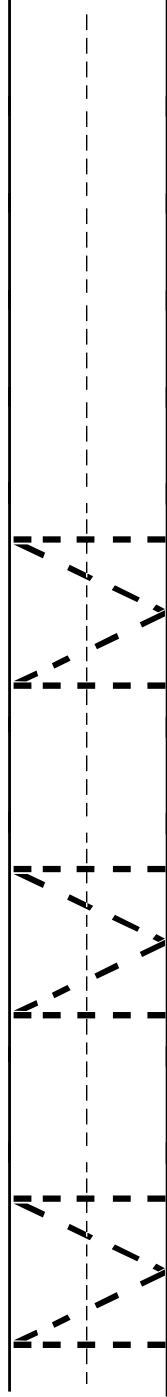
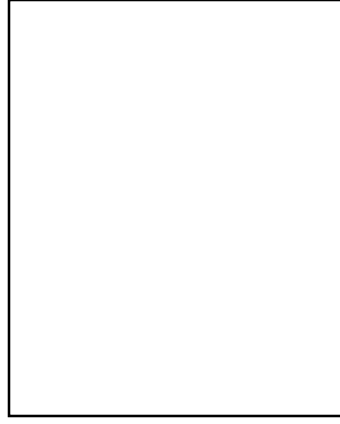
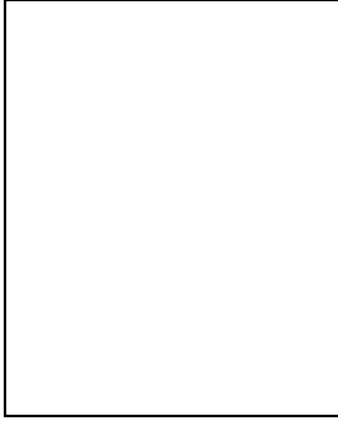

Name: _____

Mm

Read the sentence. Color the picture.

M is for

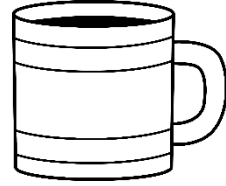

.

M is for

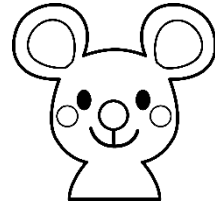

.

M is for

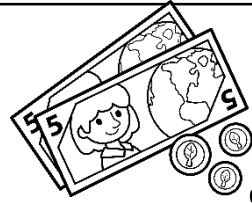

.

M is for



.

M is for

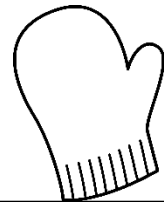

.

M is for

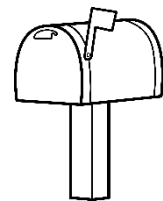

.



Name _____

M

Cut and paste the letter M and the words that begin with M onto the mouse.

n



m

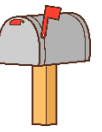

M

m



N





Name _____

M

Cut and paste the letter M and the words that begin with M onto the mouse.

n

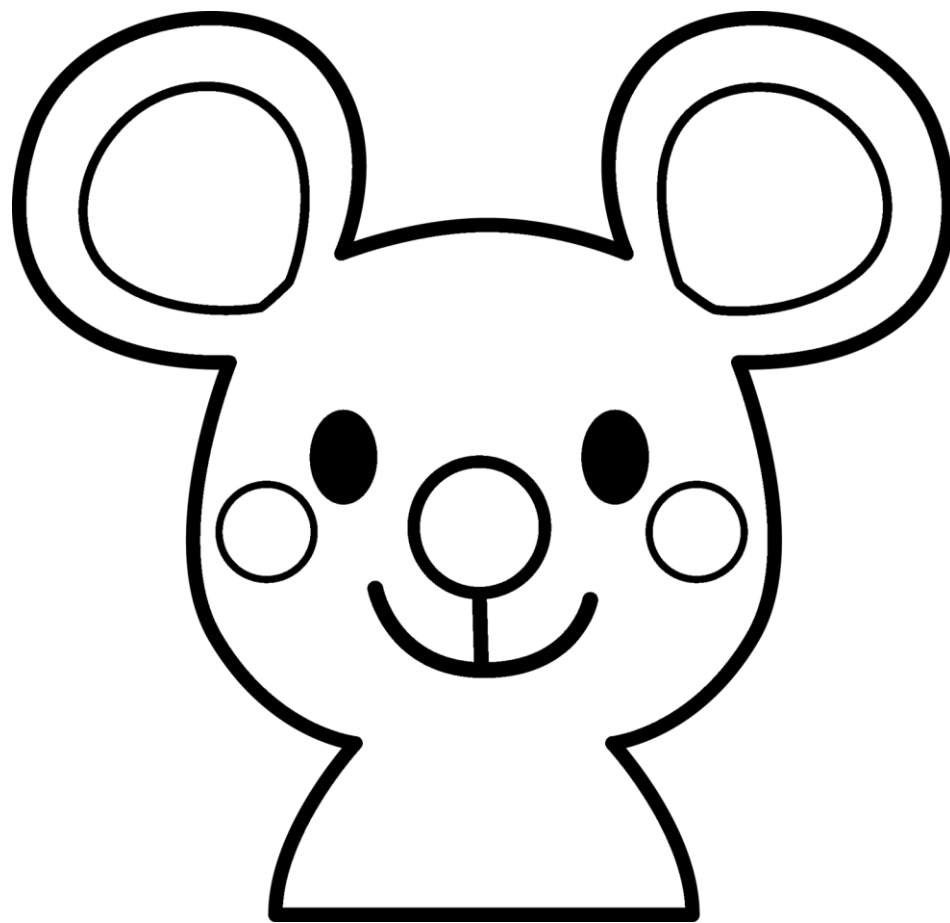

m

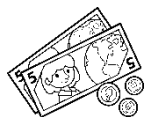

M

m

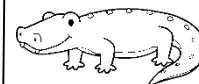

N



Dot the Letters: M m

Use the bingo dabbers to "dot" the letters:

M =

m =

M is for Mushroom

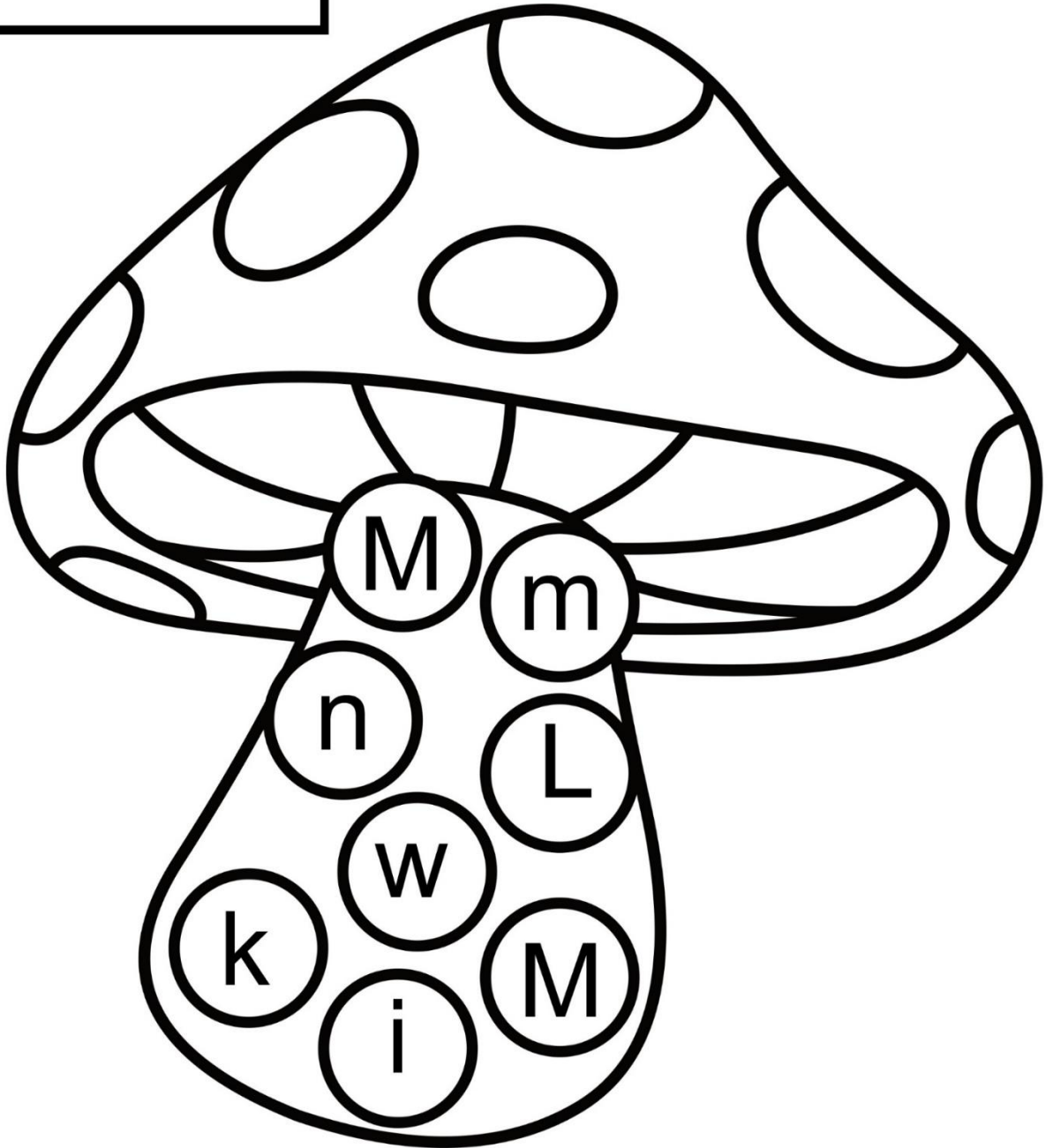

Thank you to our illustrators for this project... you make us look great!



LittleRed's
CLIP ART

www.teachersnotebook.com/shop/LittleRedsClipArt

Thank you to the illustrator..you make us look great!



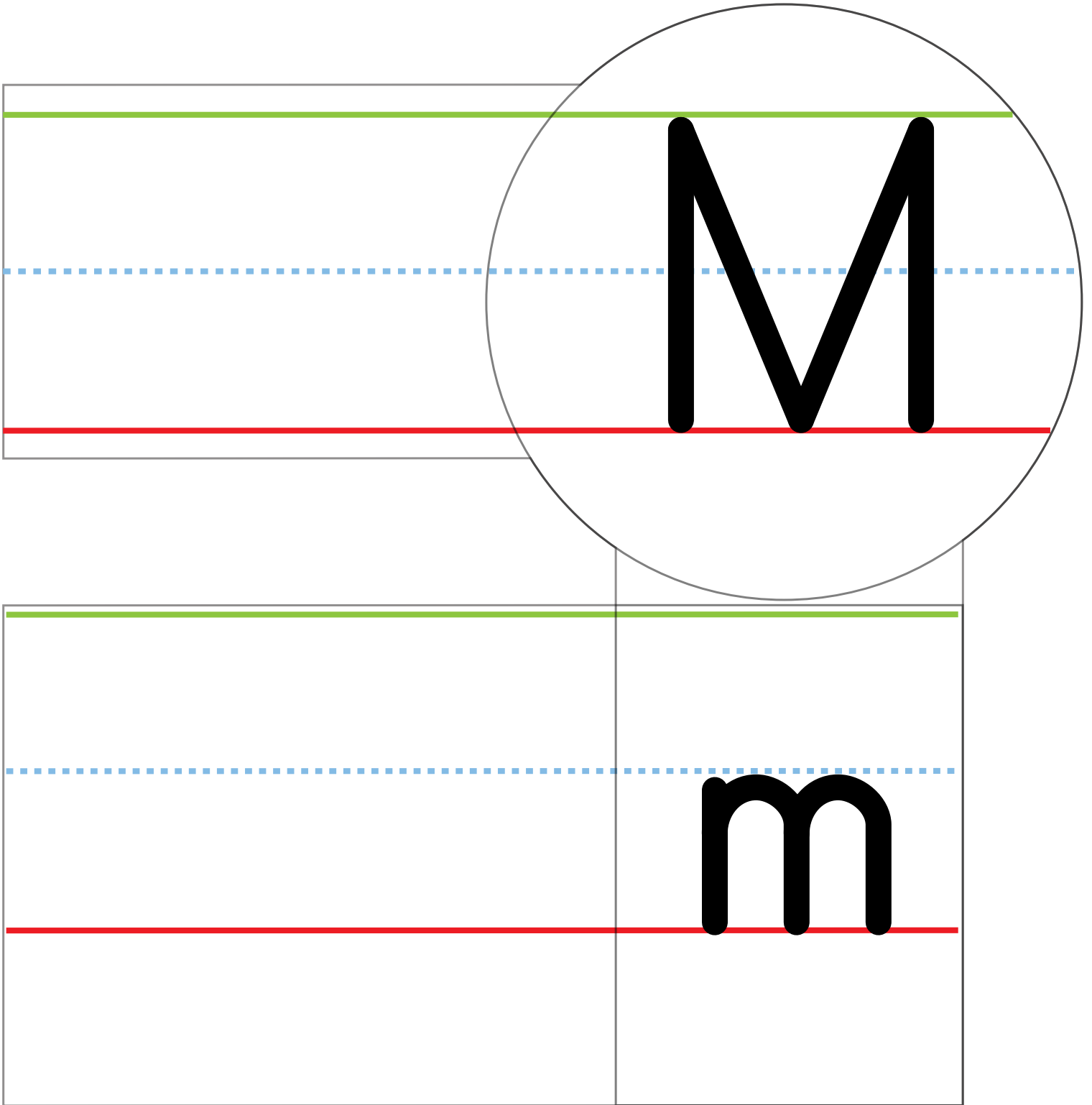

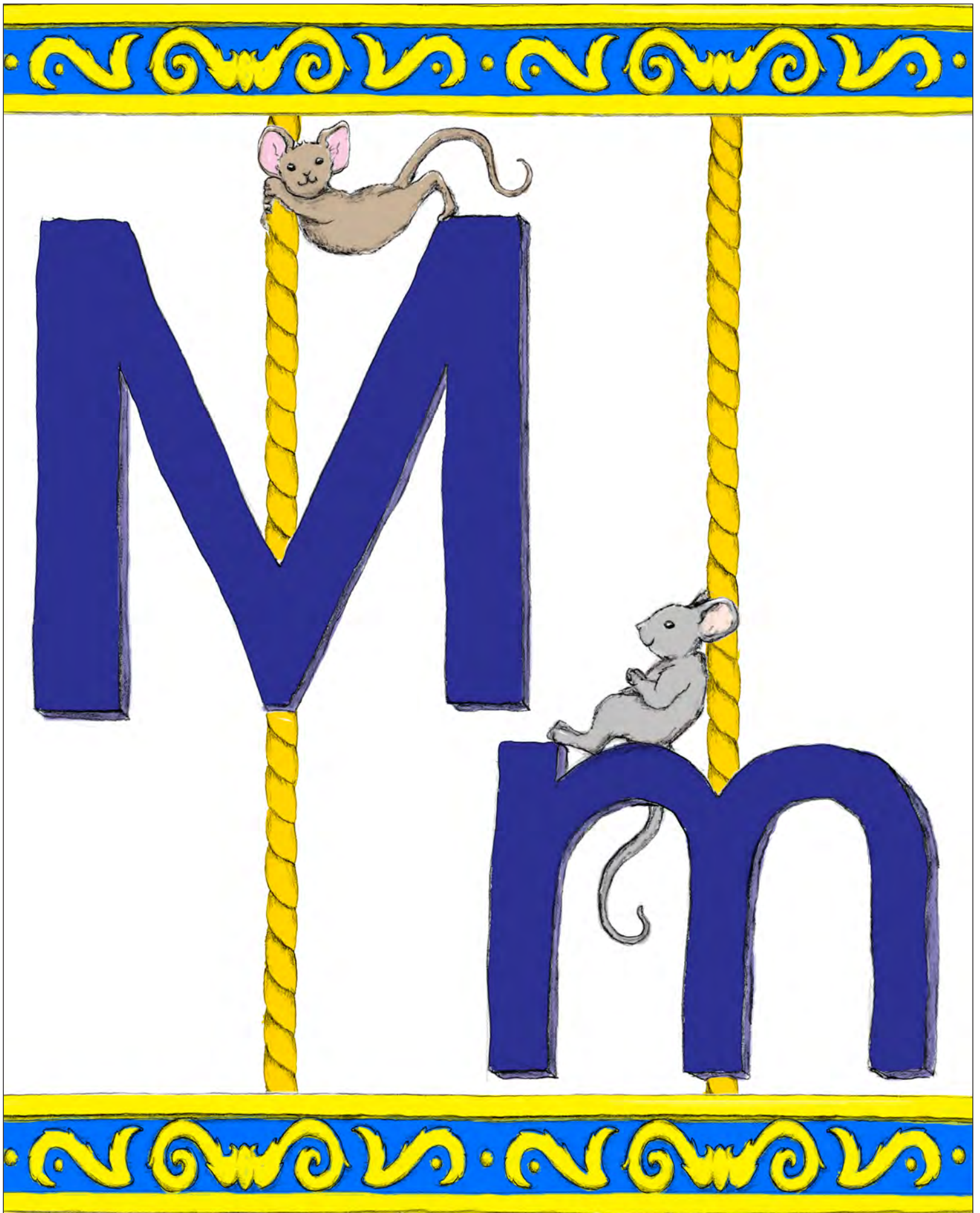



My

Mm

Book

By _____

©Mrs. Karle's Sight and Sound Reading™

This is an uppercase M

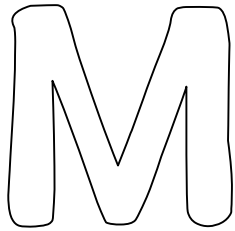

Trace the uppercase M

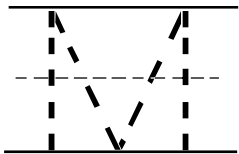

Highlight the uppercase M

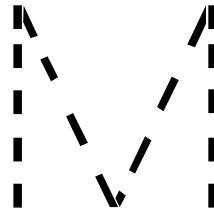

Write the uppercase M

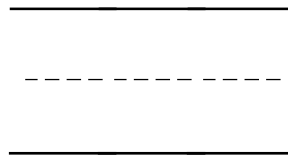

This is a lowercase m

Highlight the lowercase m

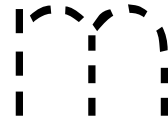
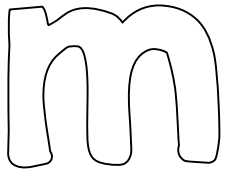

Trace the lowercase m

Write the lowercase M

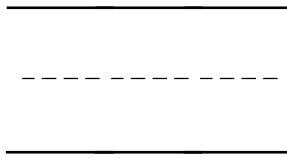
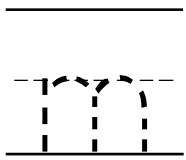

Color pictures that begin with m

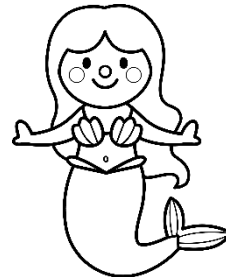
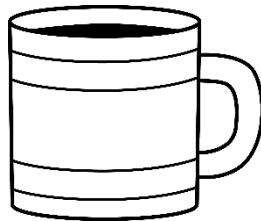
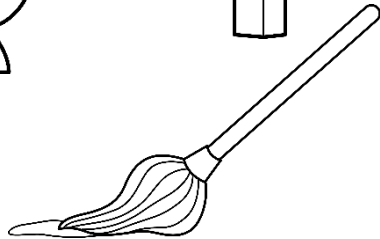
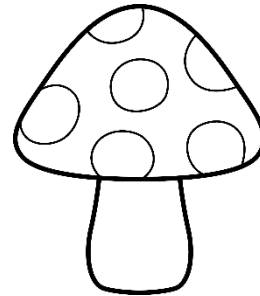
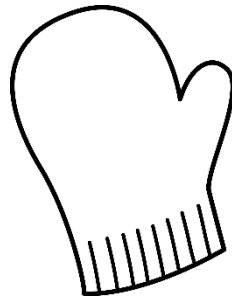
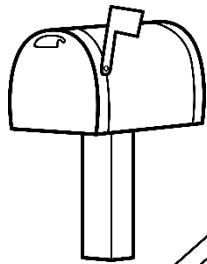
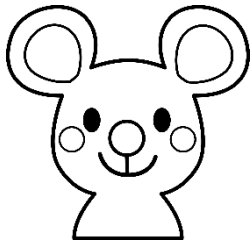

Trace and write the letter.

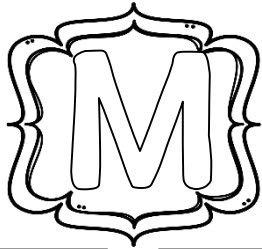
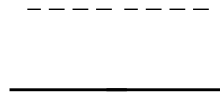
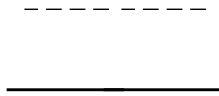
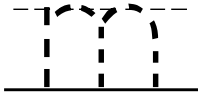
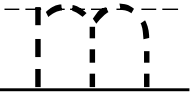
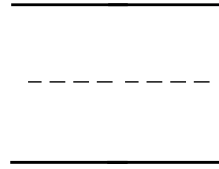
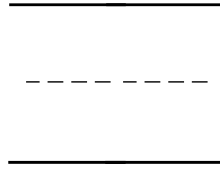
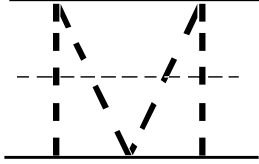
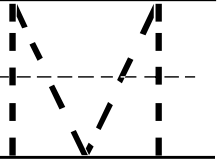

Cut and Paste.

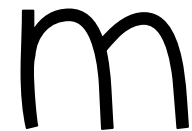
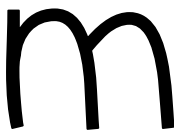
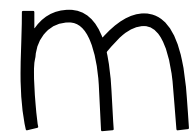
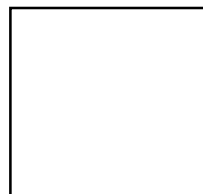
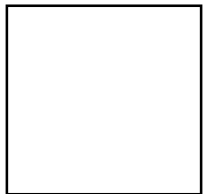
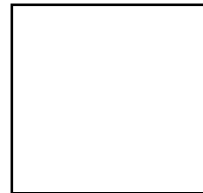
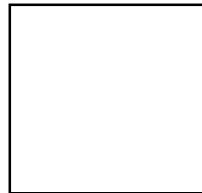
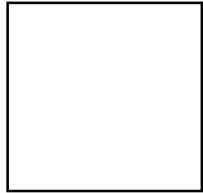
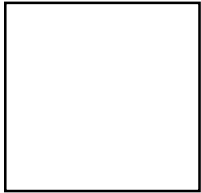
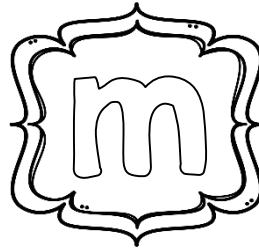

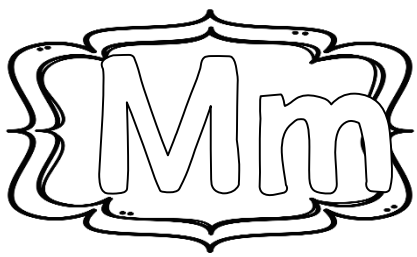

Cut and Paste.

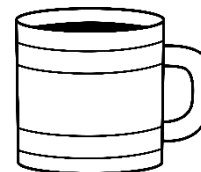
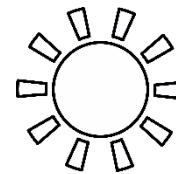
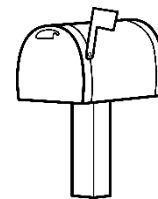
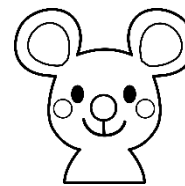
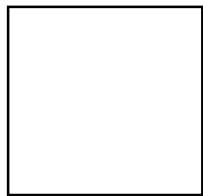
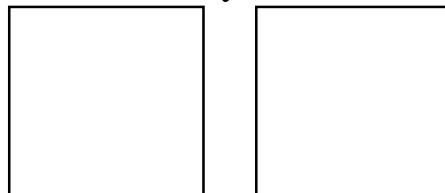
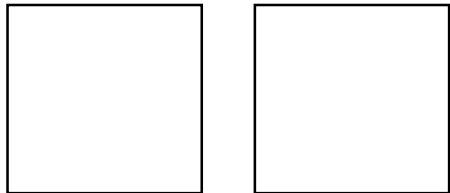
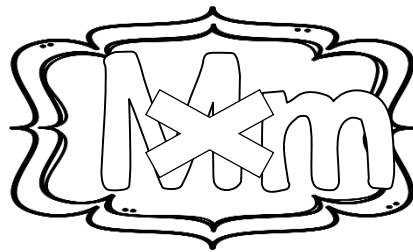

Color.

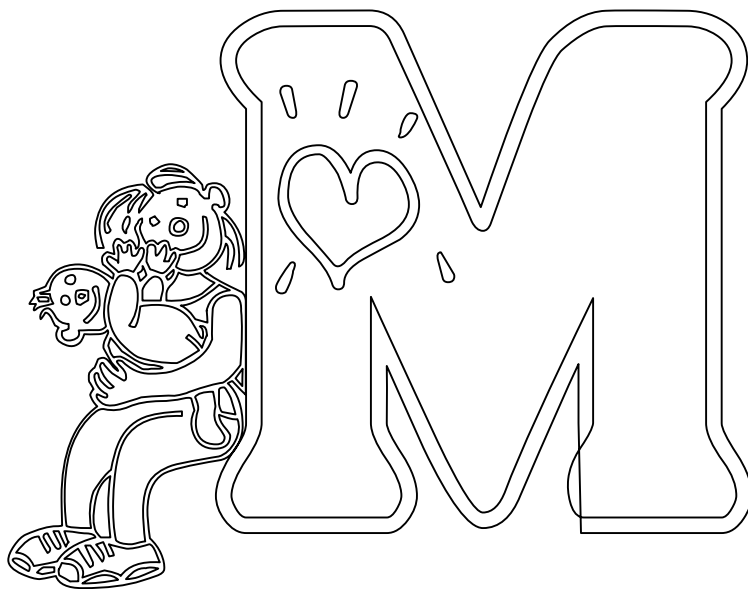

Thank you to our illustrator..you make us
look great!



<http://littleredscipart.etsy.com>



Letter Mm
Coloring Pages



Name: _____

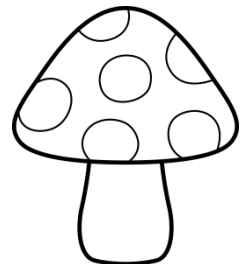
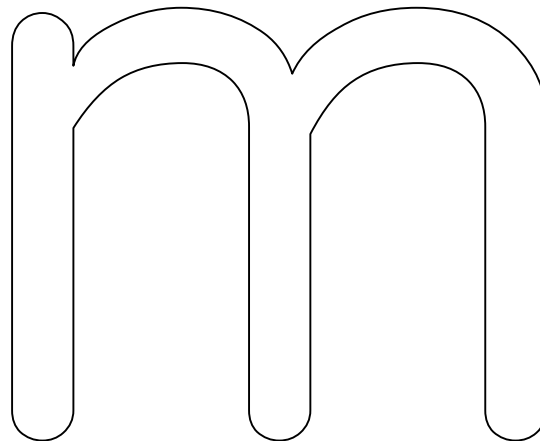
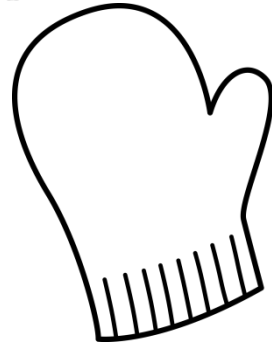
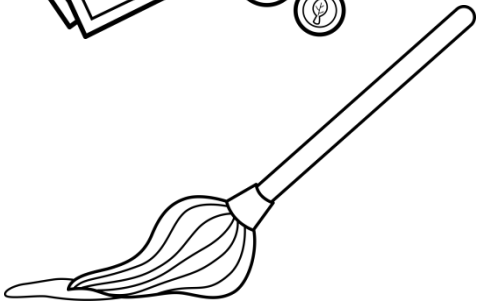
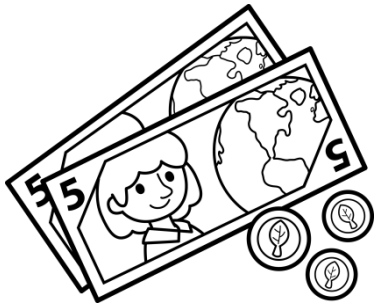
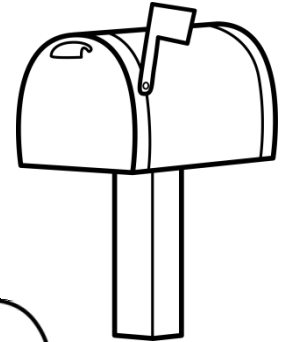
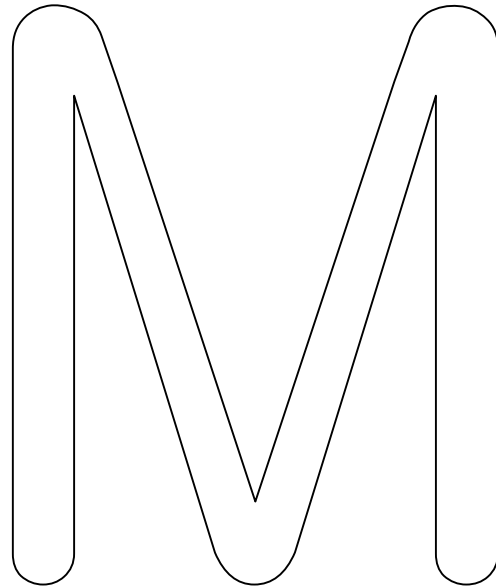
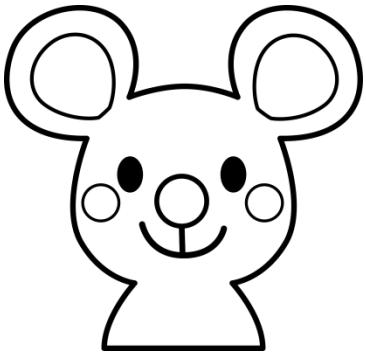

Name: _____

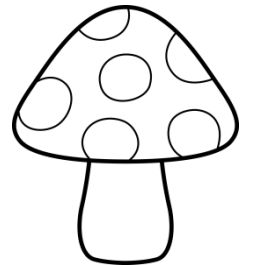
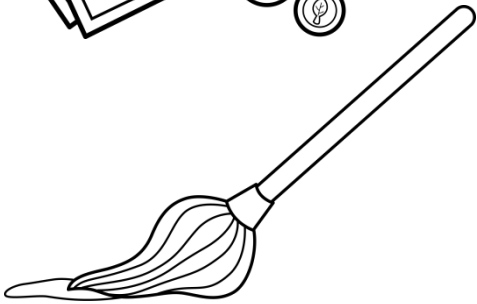
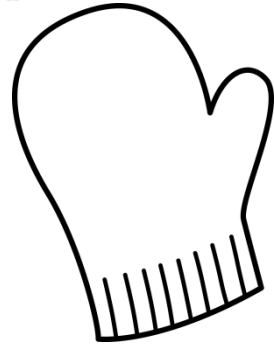
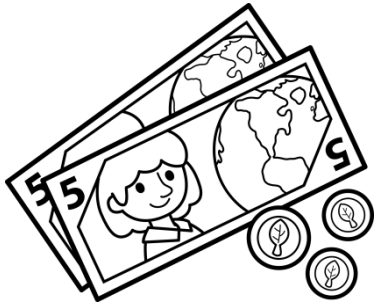
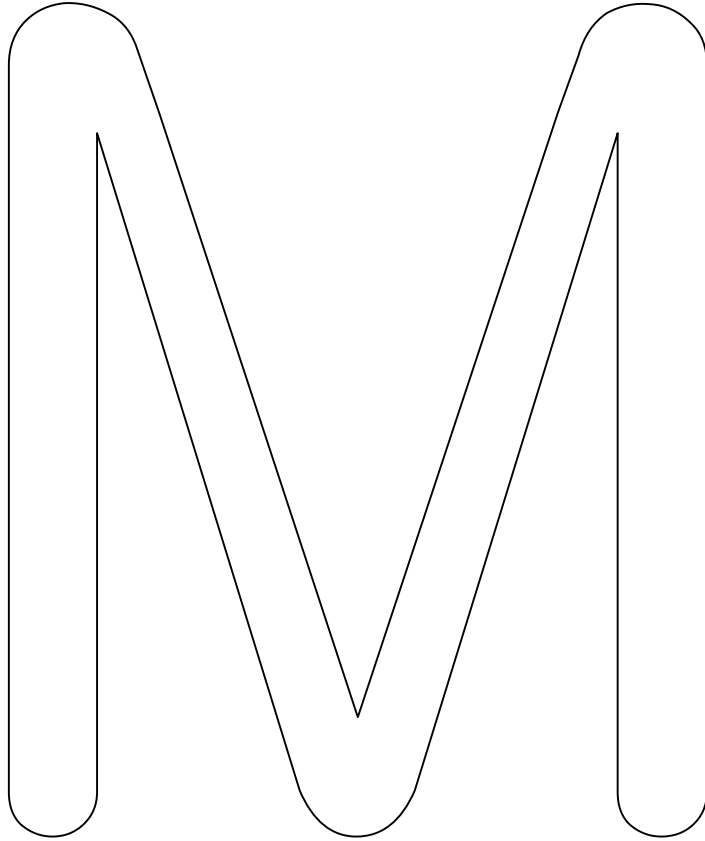
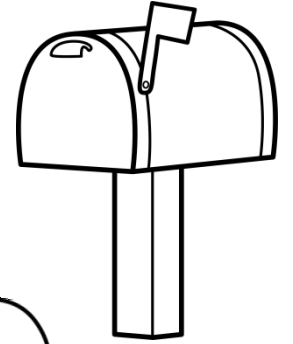
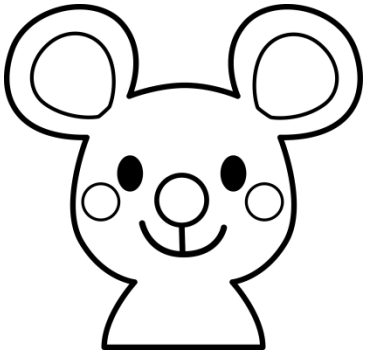

Name: _____

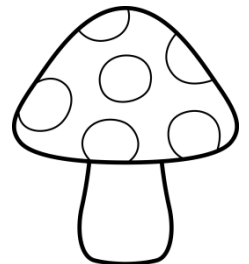
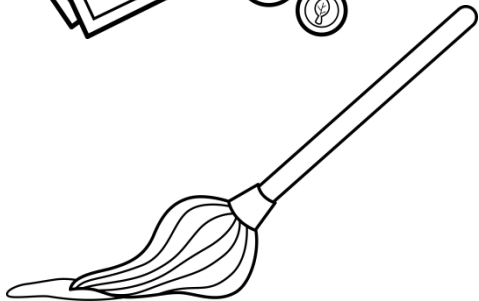
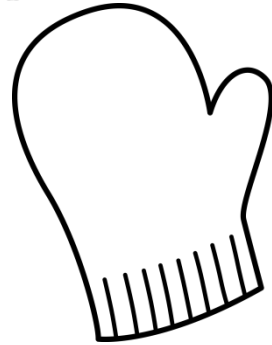
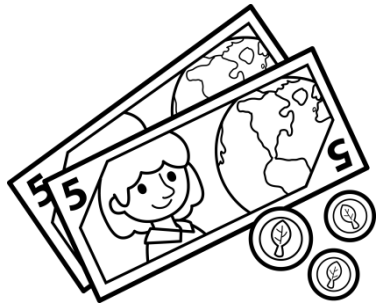
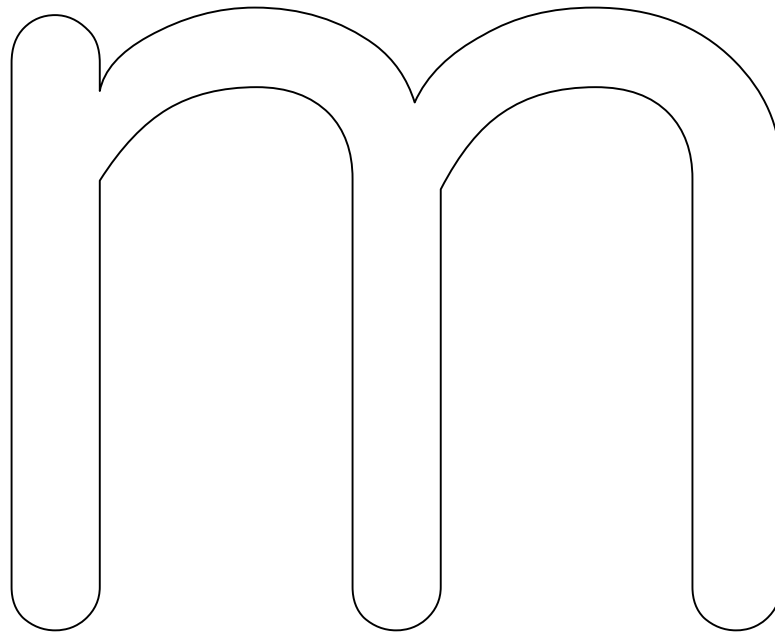
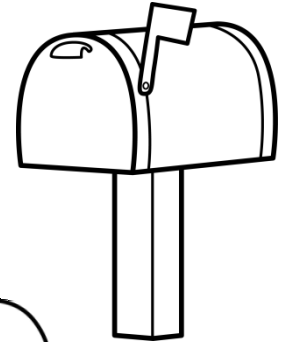
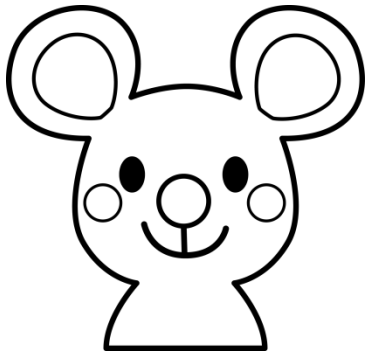

Thank you to our Illustrators for this book:

Artemis B

Little Red's Schoolhouse

